

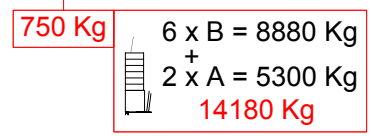

# H-32

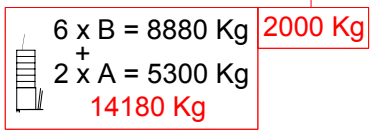

SR / 2T

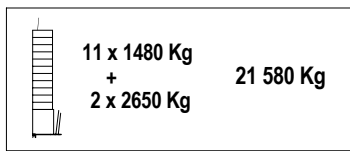
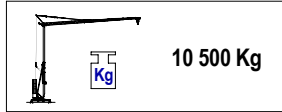
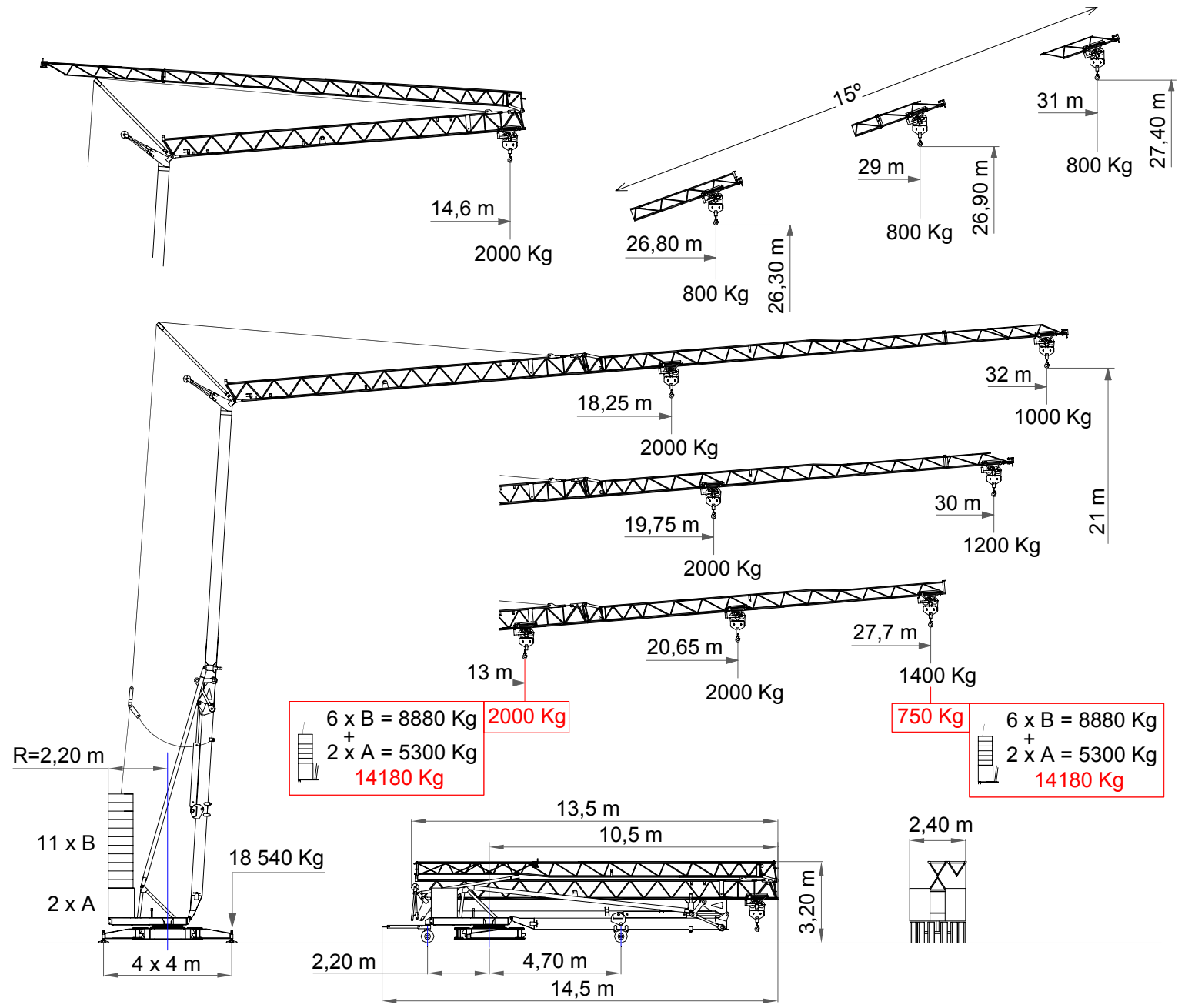

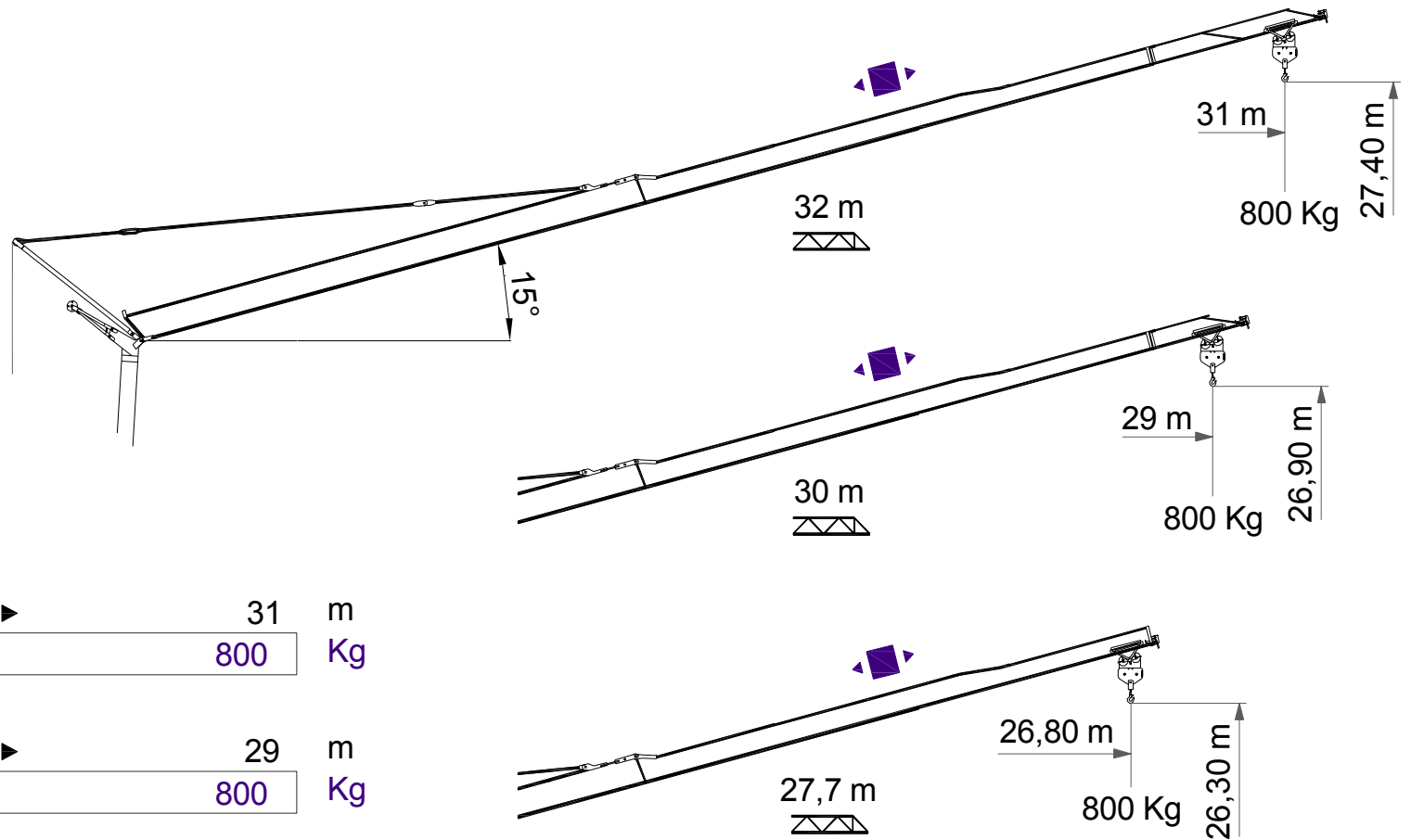

Flecha izada  
 Luffing jib  
 Ausleger in  
 steilstellung  
 Flèche relevée  
 Braccio impennato



|   |                                  |         |    |
|---|----------------------------------|---------|----|
| 32 m  | 0 ▶                              | 31 m    |    |
|    | <input type="text" value="800"/> |         | Kg |
| 30 m  | 0 ▶                              | 29 m    |    |
|  | <input type="text" value="800"/> |         | Kg |
| 27,7 m  | 0 ▶                              | 26,80 m |    |
|  | <input type="text" value="800"/> |         | Kg |

Mecanismos  
Mechanisms  
Antriebe  
Mécanismes  
Meccanismi

|  |       |      |      |      |
|--|-------|------|------|------|
|  |       |      |      |      |
|  | m/min | 5    | 20'5 | 41   |
|  | Kg    | 2000 | 2000 | 1000 |
|  | Kw    | 1'8  | 7'5  | 7'5  |
|  | m/min | 18'5 |      | 37   |
|  | Kg    | 2000 |      | 2000 |
|  | Kw    | 0'75 |      | 1'5  |
|  | r.p.m | 0'25 | 0'5  | 0'8  |
|  | N.m   | 30   |      |      |
|  | Kw    | 4    |      |      |

- Elevación / Hoisting / Heben / Levage / Sollevamento
- Distribución / Trolleying / Katzfahren / Distribution / Distributions
- Orientación / Slewing / Schwenken / Orientation / Rotazione
- Montaje / Erection / Montage / Montage / Montaggio

|                |       |
|----------------|-------|
|                |       |
| 400 V<br>50 Hz | 13 Kw |

Montaje  
Erection  
Montage  
Montage  
Montaggio

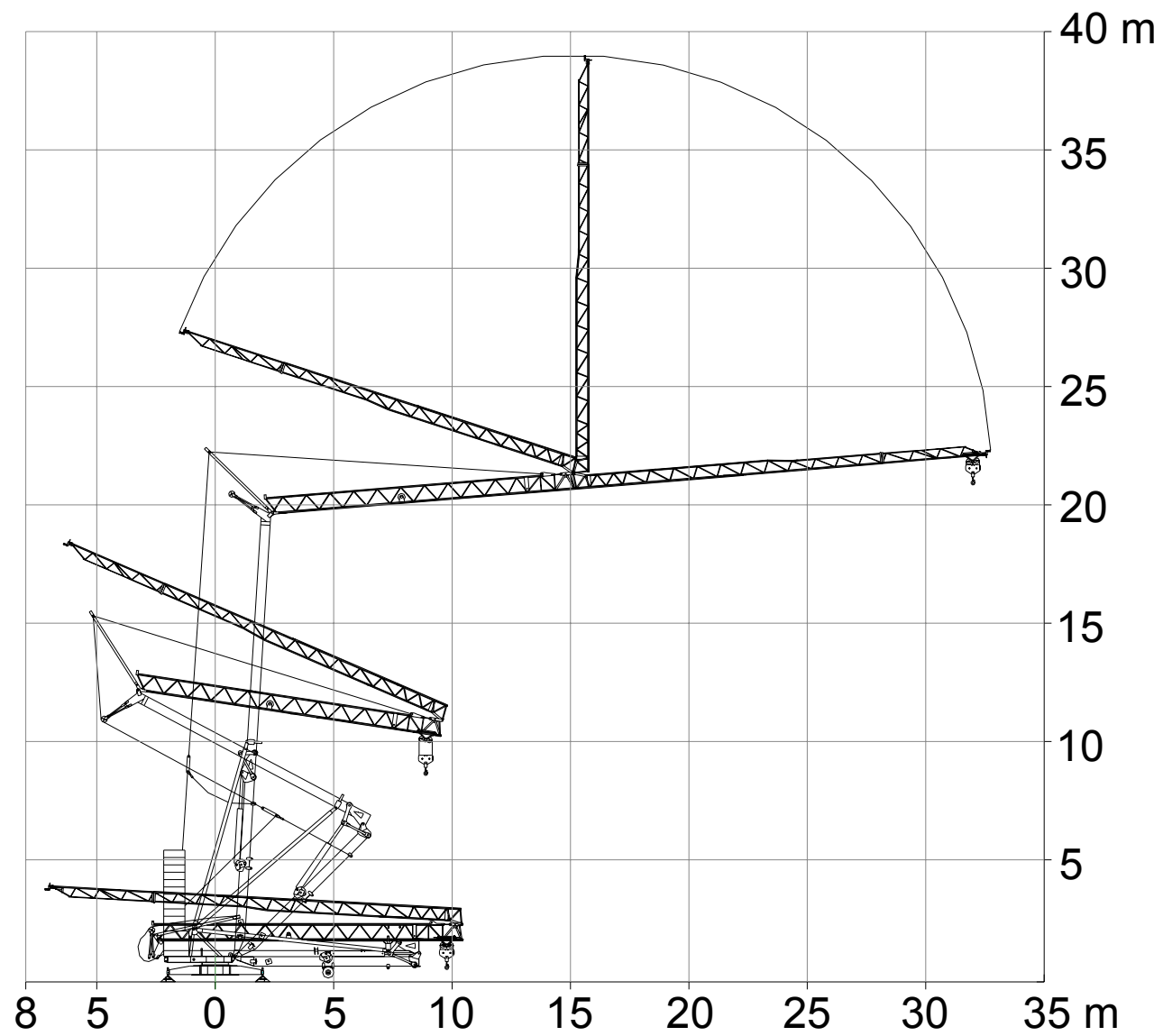

**H-32 SR / 2T**



ESPECIFICACIONES SUJETAS A MODIFICACIONES SIN PREVIO AVISO.  
Specifications subject to modification without notice.  
Obiges kann ohne berstaendigung geaendert werden.  
Specifications susceptibles de modification sans avis préalable.  
Specifiche suscettibili di variazioni senza preavviso.

DECLINAMOS TODA RESPONSABILIDAD DERIVADA DE LA INFORMACION PROPORCIONADA.  
This information is supplied without liability.  
Sämtliche Angaben erfolgen ohne Gewähr.  
Ces renseignements sont sans garantie.  
Le indicazioni contenute si intendono salvo errori ed omissioni.