

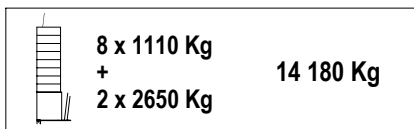

H-28

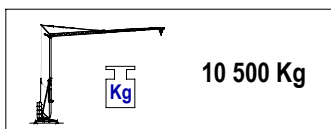

DIN 15018

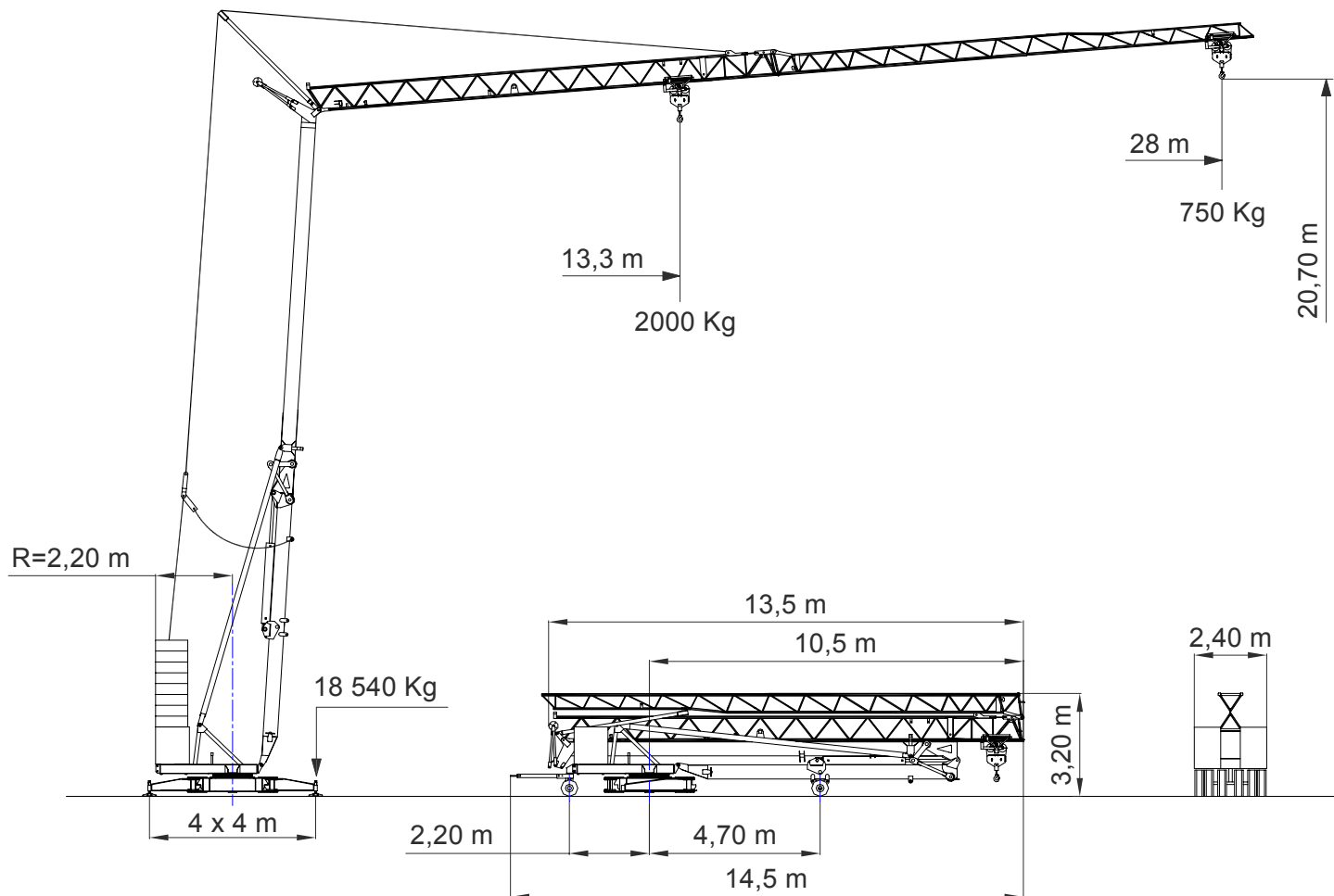
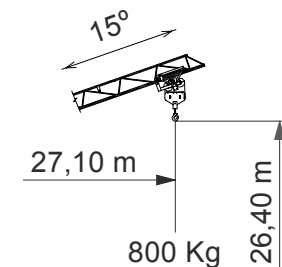
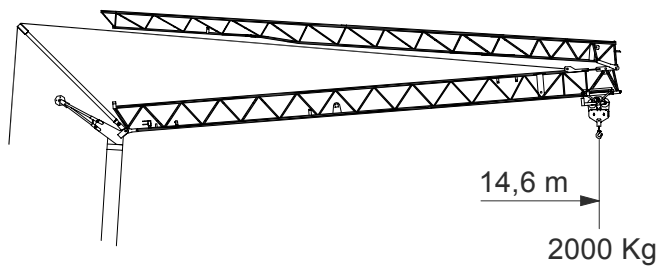

Curvas de cargas
Load diagrams
Lastkurven
Courbes de charges
Curve di carico

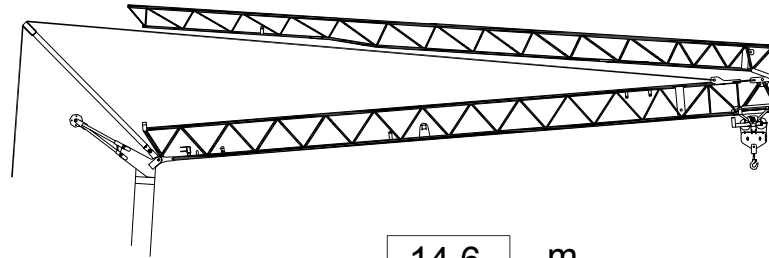

14,6	m
2000	Kg

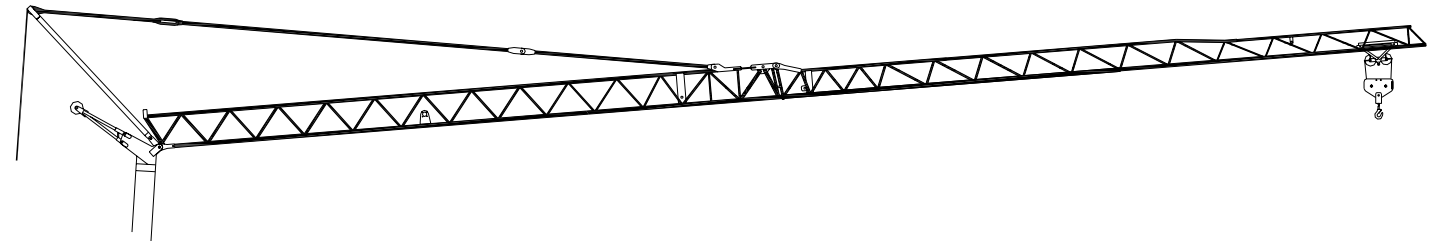





13,3	16	18	20	22	24	26	28	m
2000	1566	1341	1168	1031	920	827	750	Kg

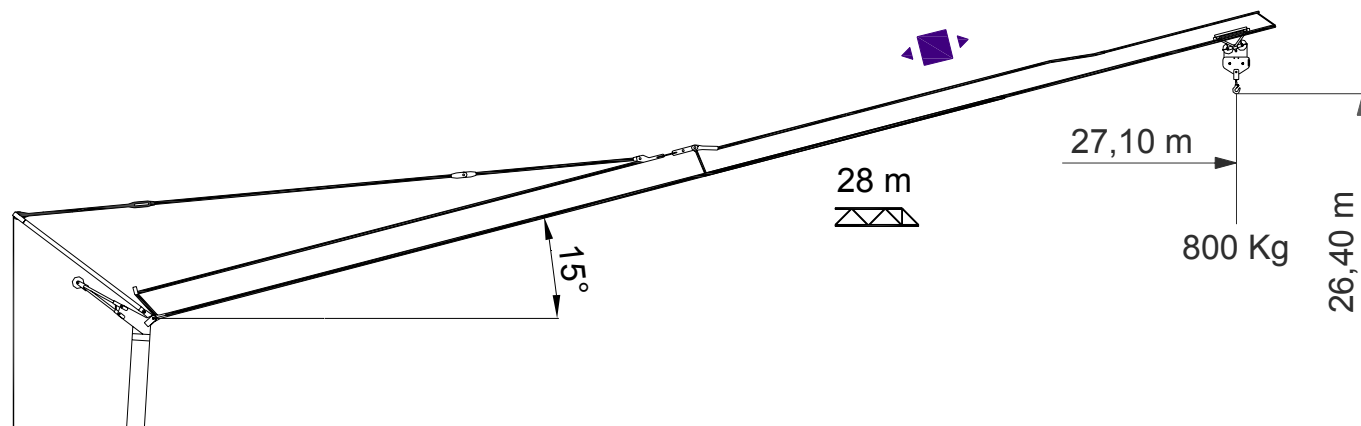





Flecha izada
Luffing jib
Ausleger in
steilstellung
Flèche relevée
Braccio impennato



Mecanismos
Mechanisms
Antriebe
Mécanismes
Meccanismi

				
	m/min	5	20'5	41
	Kg	2000	2000	1000
	Kw	1'8	7'5	7'5
	m/min	18'5		37
	Kg	2000		2000
	Kw	0'75		1'5
	r.p.m	0'25	0'5	0'8
	N.m	30		
	Kw	4		

-  Elevación / Hoisting / Heben / Levage / Sollevamento
-  Distribución / Trolleying / Katzfahren / Distribution / Distributions
-  Orientación / Slewing / Schwenken / Orientation / Rotazione
-  Montaje / Erection / Montage / Montage / Montaggio

	
400 V 50 Hz	13 Kw



Montaje
Erection
Montage
Montage
Montaggio



ESPECIFICACIONES SUJETAS A MODIFICACIONES SIN PREVIO AVISO.
Specifications subject to modification without notice.
Obiges kann ohne berstaendigung geaendert werden.
Specifications susceptibles de modification sans avis préalable.
Specifiche suscettibili di variazioni senza preavviso.

DECLINAMOS TODA RESPONSABILIDAD DERIVADA DE LA INFORMACION PROPORCIONADA.
This information is supplied without liability.
Sämtliche Angaben erfolgen ohne Gewähr.
Ces renseignements sont sans garantie.
Le indicazioni contenute si intendono salvo errori ed omissioni.



Santana UA Group LLC

www.s-bud.com.ua

Tel.: +38044 3320553. 3312332

e-mail s-bud@i.ua